

OWNER'S MANUAL

Climate Wizard CW3 Dual System

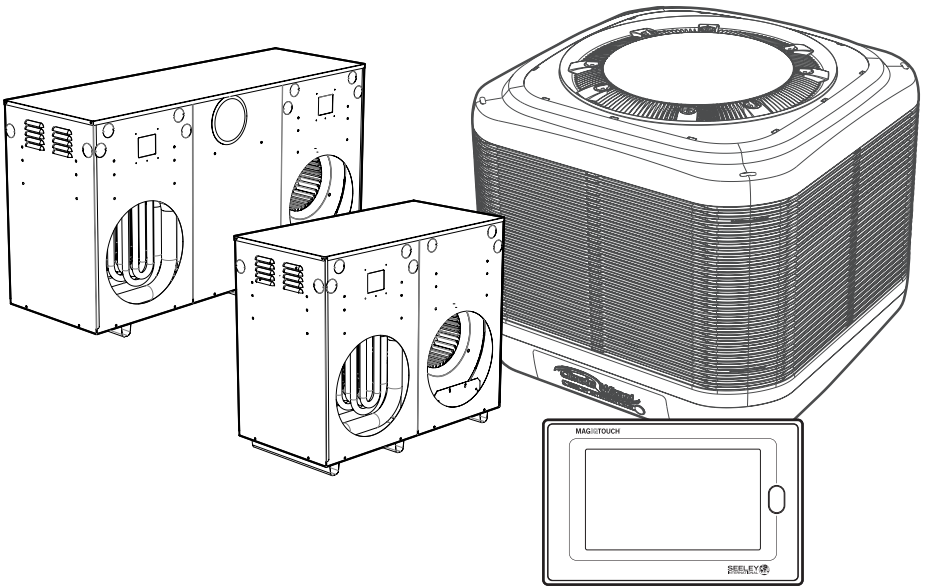

(English)

IMPORTANT SAFETY INSTRUCTIONS

READ AND SAVE THESE INSTRUCTIONS FOR FUTURE REFERENCE. FOR EUROPE

This appliance can be used by children aged from 8 years and above and persons with reduced physical, sensory or mental capabilities or lack of experience and knowledge if they have been given supervision or instruction concerning use of the appliance in a safe way and understand the hazards involved. Children shall not play with the appliance. Cleaning and user maintenance shall not be made by children without supervision.

FOR AUSTRALIA, NEW ZEALAND & OTHER NON-EUROPEAN COUNTRIES

This appliance is not intended for use by persons (including children) with reduced physical, sensory or mental capabilities, or lack of experience and knowledge, unless they have been given supervision or instruction concerning use of the appliance by a person responsible for their safety. Children should be supervised to ensure that they do not play with the appliance.

If the supply cord is damaged, it must be replaced by the manufacturer, its service agent or similarly qualified persons in order to avoid a hazard.

New hose sets supplied with the appliance are to be used and old hose-sets should not be re-used.

WARNING – This appliance is fitted with a fuse that may operate should a fault occur. Only replace with a fuse of equivalent rating: T10AH 250V, size 5 x 20mm

WARNING - TO REDUCE THE RISK OF FIRE, ELECTRIC SHOCK, OR INJURY TO PERSONS, OBSERVE THE FOLLOWING:

- a) Use this unit only in the manner intended by the manufacturer. If you have questions, contact the manufacturer.
- b) Before servicing or cleaning unit, switch power off at service panel and lock the service disconnecting means to prevent power from being switched on accidentally. When the service disconnecting means cannot be locked, securely fasten a prominent warning device, such as a tag, to the service panel.

IMPORTANT SAFETY INSTRUCTIONS

Never force parts to fit because all parts are designed to fit together easily without undue force.

Never drill holes in the cooler's water reservoir.

IMPORTANT NOTES!

In areas where temperatures can cause water supply pipes to freeze, a drain down facility should be provided during the installation. This drain down facility must be activated prior to freezing conditions, to avoid possible damage to the cooler components.

As with any product that has moving parts or is subject to wear and tear, it is **VERY IMPORTANT** that you maintain the product and have it regularly serviced. It is a condition of warranty cover for your product that you comply with all of the maintenance and service requirements set out in the Owner's Manual. Compliance with these requirements will prolong the life of your product.

TABLE OF CONTENTS

OPERATING THE SYSTEM	1
MAGIQTOUCH CONTROLLER OPERATION	1
GENERAL TIPS	2
QUICK REFERENCE	2
CONTROLLER SETTINGS	3
QUICK START	4
OPERATION	
Navigation	7
Manual Mode - Cooling	7
Manual Mode - Heating	8
Appliance Mode	8
Program Mode	9
SETTINGS MENU	
General Menu	13
Cooling & Heating Menus	13
Service Menu	14
WARNINGS & SERVICE MESSAGES	15
SLAVE CONTROLLERS	16
POWER OUTAGES	16
CONTROLLER TROUBLE SHOOTING	16
REMOVING SIDE PANELS	17
ACCESS FOR SERVICING AND MAINTENANCE	17
SEASONAL MAINTENANCE	
Pre-Season	18
During Season	18
End of Season	18
MAINTENANCE SCHEDULE ROOFTOP COOLING UNIT	20
TROUBLESHOOTING ROOFTOP COOLING UNIT	21
MAINTENANCE SCHEDULE HEATING UNIT	22
TROUBLESHOOTING HEATING UNIT	23
HOW TO REGISTER YOUR WARRANTY (Australia Only)	24
WARRANTY TERMS AND CONDITIONS (Australia Only)	25

Hello and congratulations on purchasing a Seeley Climate Wizard CW3 Dual System

At Seeley International we manufacture Climate Wizard® Air Conditioning systems from the highest quality materials, and we have designed the product to provide many years of economical, trouble-free air comfort and control.

OPERATING THE SYSTEM

Ensure the air flow to the return air duct is not impeded or diluted by open windows or open/closed doors.

There are three main ways that a CW3 Dual System can operate to provide comfort.

- The system can be set at a constant fan speed, without reference to the current temperature.
- The system can be given a temperature target, in which case it will vary the fan speed (in cooling mode) or turn the fan on or off (in heating mode) in order to get as close to the target as possible. (Note! Humid weather conditions may limit what cooling temperatures can be achieved.)
- The system can be set to a fan only mode, providing air circulation only.

GENERAL TIPS

- Mount the MagIQtouch Controller in a room you want climate controlled. Ideally it should be positioned 1.5m (5') from the floor and away from any other heating or cooling sources.
- Ensure the MagIQtouch Controller is not exposed to direct sunlight as this will impact the temperature reading.
- Avoid blocking or restricting the vent holes located in the side of the MagIQtouch Controller, as this is where the thermostat is located.
- Do not use harsh chemical cleaners to clean the touch screen. For best results use distilled water or a touchscreen specific cleaning agent with a microfibre cloth.

QUICK REFERENCE

Here's a brief visual guide to the main features of your wall controller.

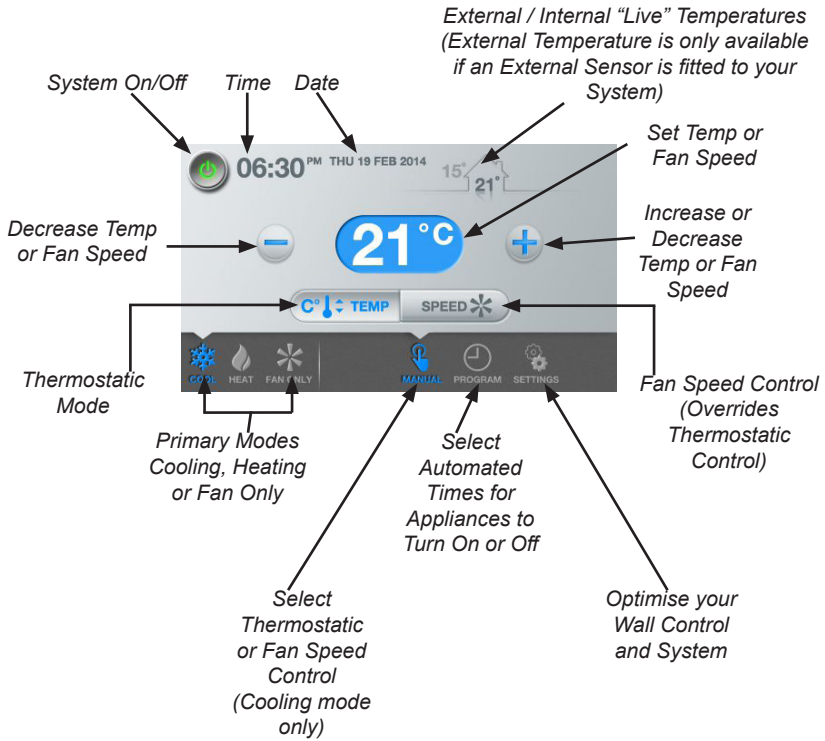

CW3 Dual System Appliances

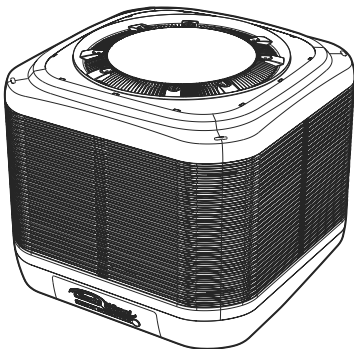

Rooftop Cooling unit

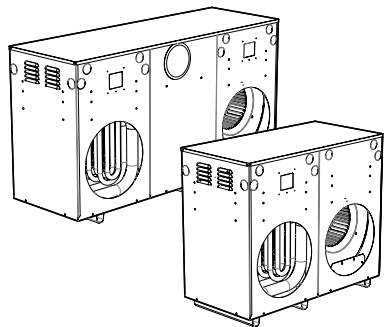

Heating unit
(2 sizes shown)

CONTROLLER SETTINGS

Your MagIQtouch Controller contains a settings menu, which gives you access to information about your CW3 Dual System and to extra functions including:

About Appliance

Access information about the appliances installed in your system.

Min/Max Set Temperature

You can change the minimum and maximum temperature displayed on your slider, depending on what temperature range you prefer your system to work within.

Night Quiet Mode

Restrict fan speed over the night time period for a quiet night's sleep.

Manual Drain

This will turn the rooftop unit off and drain the tank.

Drain and Dry

This option allows you to nominate a time each day when the rooftop unit will drain the tank and run the fan for 1 hour.

Autoclean

Select the preferred cleaning interval (50 / 100 / 200 hrs). At 8.00am after the selected running hours has been reached, the rooftop unit will drain the tank, fill with fresh water and operate the pump for 5 minutes. When complete, drains the tank and returns to previous operation mode.

External Sensor (optional)

Rooftop units can be fitted with an external air sensor. When switched on, it displays a live external ambient temperature reading on the wall controller. Where climate conditions are close to freezing, an external temperature set point can be programmed to auto drain the tank and prevent freezing conditions damaging the tank.

Note! There are some settings, which are locked and are only for installers or service technicians.

QUICK START

Here's a brief visual guide to get you started quickly!
Continue reading for detailed instructions.

Step 1

Activate screen.

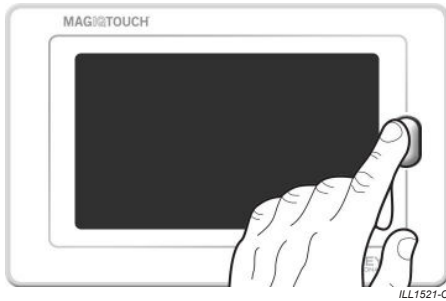

Step 2

Select mode from lower taskbar.



Step 3

Turn on cooling or heating or fan only mode

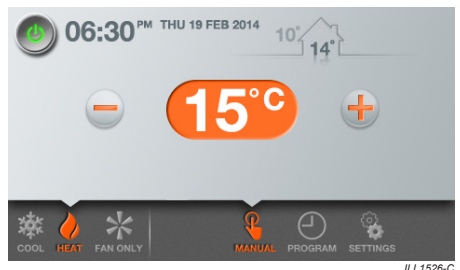

QUICK START cont

Step 4

Set desired temperature.



ILL1527-C



ILL1528-C

Step 5

Switch between thermostatic control to fan speed control. (cooling mode only)

Note: When in thermostatic mode the fan speed automatically adjusts to achieve set temperature.



ILL2413-A



ILL2414-A

QUICK START cont

Step 6

Access wall control and system settings in the SETTINGS menu.



OPERATION

NAVIGATION

There are a few things you might need to know in order to navigate your new MagIQtouch Controller.

The following section outlines some of the sliders and buttons you will need to use.



ILL1535-A

Press mode option buttons:
Make your selection(s):



ILL1541-B



ILL1537-A

The header is the top section of your screen. This is where, most importantly, you'll find the on/off button for your system.



ILL1538-A

The lower taskbar is the section at the bottom of the screen. This is where you'll be able to select your primary mode (cooling, heating or fan only). Just be aware that you'll only see icons that are relevant to your installation as the MagIQtouch Controller knows what it's attached to.



ILL1539-A

MANUAL MODE - COOLING

In cooling mode, manual TEMP mode will try to maintain the temperature you want by speeding up or slowing down the fan.

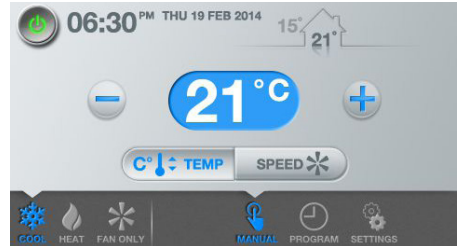

ILL1544-C

Alternatively, using manual SPEED mode, you can choose to disregard the room temperature and keep the cooler running at a constant fan speed.



ILL1545-B

OPERATION cont

MANUAL MODE - HEATING

In heating mode, manual TEMP mode will try to maintain the temperature you want by starting or stopping the fan.

The room fan speed can be limited using the “SET FAN SPEED” option in the Heater system settings.

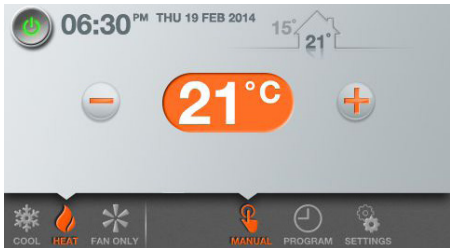

ILL2415-A

“SET FAN SPEED” in Heater SETTINGS.



ILL2420-A

Adjust speed.

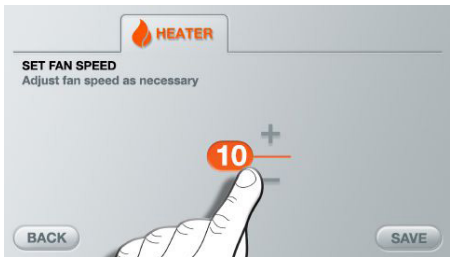

ILL2421-A

APPLIANCE MODE

While your CW3 Dual System is running in 'Temp' mode, the set temperature reading display on the MagIQtouch controller may change colour highlighting the current status of the appliance.

Status	Cooling mode	Heating mode
21°C	Appliance: ON Fan: ON Water: ON	
21°C		Appliance: ON Fan: ON Gas: ON
21°C	Appliance: ON Fan: ON Water: OFF	Appliance: ON Fan: ON Gas: OFF
21°C	Appliance: ON Fan: OFF Water: OFF (Temp achieved)	Appliance: ON Fan: OFF Gas: OFF (Temp achieved)

OPERATION cont

PROGRAM MODE

If you like routine and want to “set and forget” a seven day program that suits your lifestyle, activate PROGRAM mode. PROGRAM mode divides each day into four time periods. You decide when each of these periods begins and what you want your system to be doing.



Program mode is flexible.

If you leave or arrive home early, you can easily skip forward to the next period. The program will take over again once the next time period begins.



Or perhaps you want to make the temperature higher without permanently changing your program. The **OVERRIDE** button will allow you to temporarily change what's been set by the program until the next time period begins.



To set up a program first press the **EDIT** button on the PROGRAM home screen.



This will take you to a program overview screen where you can tap each day to see what's been set.



OPERATION cont

PROGRAM MODE cont



If your system has zones, you'll see each zone listed in rows. Just scroll up and down to view them all.



To set-up or change a time period, touch the time period and an adjustment screen will appear.



Turn the system on or off.



Adjust the start time.

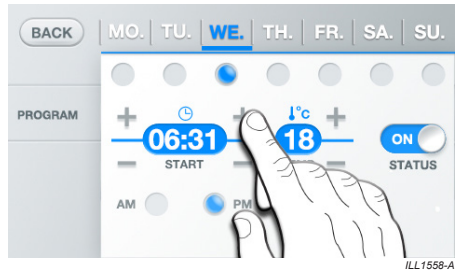

Adjust the set temperature.

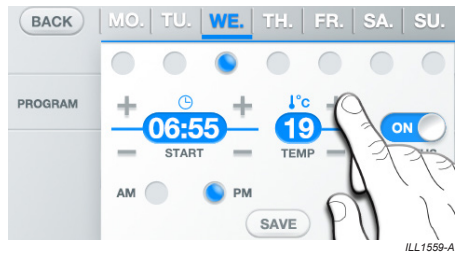

You can even link days together so you only have to make the adjustments once.



Then save your changes and you're done.



OPERATION cont

PROGRAM MODE cont

Now you can review what you've done and select another time period.



ILL1562-A

Or if you're done, press BACK to return to the program home screen.



ILL1581-C

SETTINGS MENU

The SETTINGS menu contains extra options. There are general settings for your MagIQtouch Controller and the system as a whole. You'll also find individual menus for the product(s) you have installed. At the end is a menu for service agents, to help them help you.

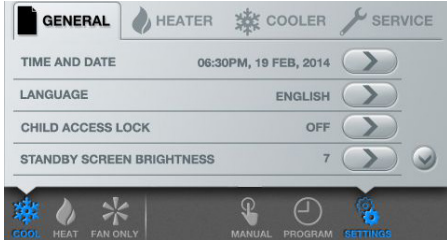

ILL1563-C

Note! The MagIQtouch Controller will only display the menus and menu items that are relevant to your system. What you see in this document may not be exactly the same as what you see on your screen. Navigate through the menus by tapping the heading tabs at the top of the screen.



ILL1564-A



ILL1565-A

All the menu items are listed on the left hand side of the screen.

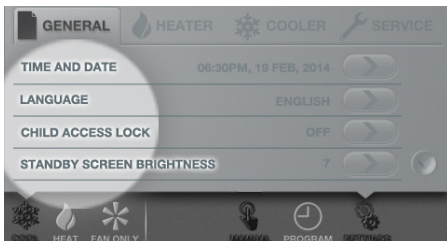

ILL1620-C

The current status is listed on the right, close to the arrow buttons.



ILL1599-C

If you want to change a setting or access a menu item, press the arrow button.

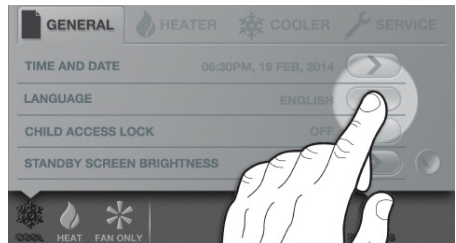

ILL1621-C

There are some settings that are just for trained service agents or installers. It is not recommended for you to access any of these options.

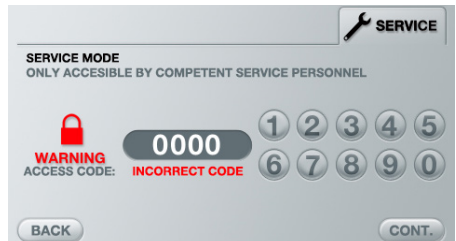

ILL1577-B

SETTINGS MENU cont

GENERAL MENU

The GENERAL menu includes settings or information related to your MagIQtouch Controller, or the system as a whole.

- Time and Date
- Language
- °C / °F (temperature unit)
- Child Access Lock (set a pin to restrict access)
- Standby Brightness (adjust standby screen brightness)
- Zone Renaming* (personalise your zone names)
- Status Information Display (for diagnostics)
- Software Revision (for diagnostics)
- Shutdown Timer
- Auto Re-start

* Only available for zoned installations.

COOLING & HEATING MENUS

The COOLER and HEATER menus include settings or information related to the specific Seeley International cooling or heating products installed within your system.

Here are some settings that are common to all cooling and heating products:

About Appliance

Access information about the appliances installed in your system.

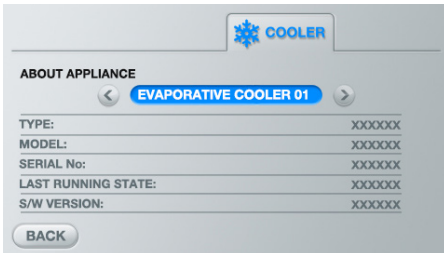

ILL1570-B

Min/Max Set Temperature

You can change the minimum and maximum temperature displayed on your operating home screen, depending on what temperature range you prefer your system to work within.

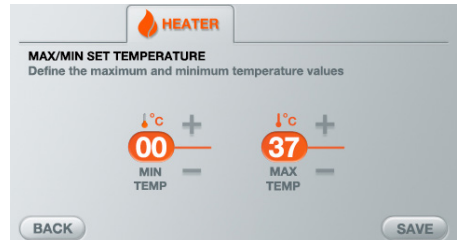

ILL1571-B

Quiet Mode

Restrict fan speed over the night time period for a quiet night's sleep.

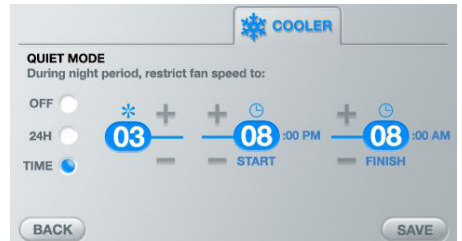

ILL1573-A

SETTINGS MENU cont

Status Information Display

When this option is turned on, a temporary information display window becomes accessible on all MANUAL and PROGRAM screens.

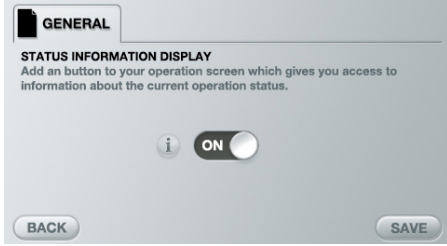

ILL1574-B

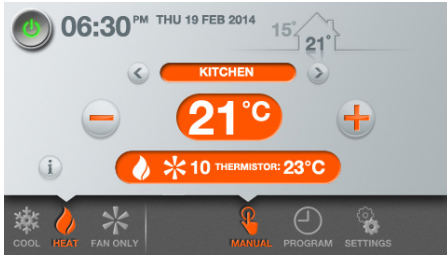

ILL1575-C

SERVICE MENU

The SERVICE menu contains information and functions for competent service personnel. Access is locked without a service pin code. We do not recommend unqualified personnel access this menu.



ILL1576-B

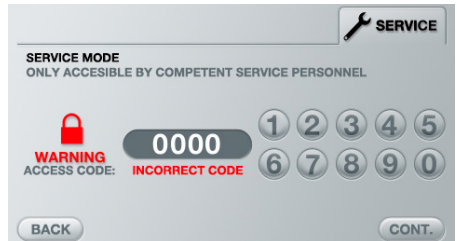

ILL1577-B

WARNINGS & SERVICE MESSAGES

Your MagIQtouch Controller will operate to make sure everything is as it should be. If it detects a change or a problem, it will notify you immediately.

Perhaps you've turned off the power to your cooler over winter. The MagIQtouch Controller will let you know it can no longer detect the cooler and will keep attempting to communicate until normal operation is established.



ILL1576-A

Once summer comes again and you power up your cooler, the MagIQtouch Controller will automatically detect the cooler and restore all functionality.

If a service issue occurs, there are some features to help you resolve it as quickly as possible. Follow the screen prompts which will either help you fix the issue yourself or display information which will be helpful when you call your local service agent.

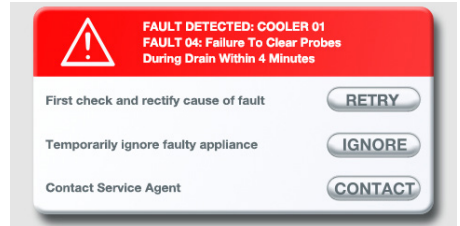

ILL1579-B



ILL1580-B

SLAVE CONTROLLERS

Multiple MagIQtouch Controllers can be used to control individual zones. In such installations there is always one “master controller” located in a nominated “master zone”. All other controllers become “slave controllers”.

In such systems there are certain principles that apply:

- If the master controller is set to OFF, no other zone can be turned on.
- If the master controller is set to ON, zones can be turned on and off from the slave controllers.
- The primary operating mode (HEAT, COOL and FAN ONLY) is dictated by the master controller and cannot be changed by a slave controller.
- The SETTINGS menu in a slave controller will only display options relevant for the applicable zone.

For Cooling mode:

- The Master Controller is the only active controller.
- The set temperature or fan speed can only be modified by the Master Controller.

For Heating mode:

- The secondary operating mode (MANUAL and PROGRAM) can be selected for each zone from the master and slave controllers.
- The set temperature is unique for each zone and is set from the controller located within the zone (either master or slave).
- No fan speed limit control is available. Fan speed is automatically controlled by the heater to achieve the set temperature.

POWER OUTAGES

After a power outage there will be a prompt to adjust the time and date.

If AUTO RESTART option is ON in general settings, the cooler or heater will automatically restart in the last running state before the outage.

CONTROLLER TROUBLE SHOOTING

Your MagIQtouch Controller may prompt you to call a service agent to resolve a service issue. If your controller has only recently been installed, we recommend you call your local Dealer for support first. Otherwise, call the Service number on the back of this manual.

Symptom	Cause	Action
The MagIQtouch Controller has no display.	The cable from cooler may not be fitted correctly.	Refit cable.
	Cable damaged or broken.	Replace cable.
The MagIQtouch Controller shows my system is on, but I can't hear the fan working.	The set temperature has been achieved and the system is in standby.	None required.
	The Controller is in PROGRAM mode and the current time period specifies the cooler/ heater is "OFF".	Review the schedule via the EDIT button on the PROGRAM home screen.

ACCESS FOR SERVICING AND MAINTENANCE

The CW3 Dual System rooftop unit should be installed in a position that allows adequate access for installation, and future maintenance and servicing activities. This should comply with installation guidelines and any local, State and National regulations.

Consider the following for installation location:-

- Which is structurally capable of supporting the weight of the rooftop unit and service technicians
- Which has clear access to and around the rooftop unit
- Which is clear of fixtures in line with below clearances
- Which is clear of fall edges (> 3m away)

Required clearances around the rooftop unit for future maintenance and servicing are shown below.

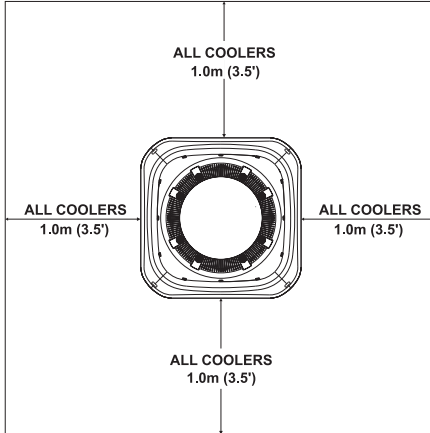

ILL2987-A

Extra service or warranty charges may apply for the cost of any equipment or additional labour involved in accessing the rooftop unit if these guidelines are not met.

REMOVING SIDE PANELS

To remove a side panel:

1. Insert a flat head screw driver into the gap between the lid and the top of the side panel. Lever it so the side panel is released.
2. Remove the clips holding the panel in place (2 on each corner of the cooler). Use a screwdriver to lever the clip from the outside edge.
3. Take hold of the side panel, pivot it outwards and lift it up.

CW3 Dual System Rooftop Unit

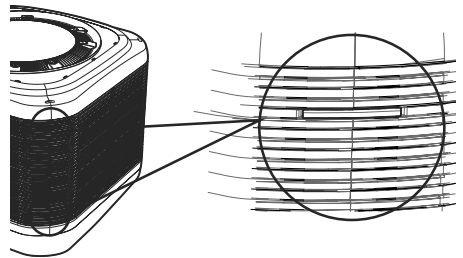

ILL2987-A

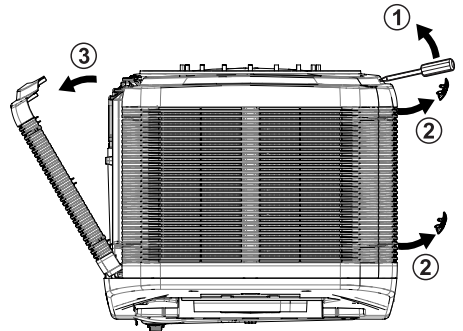

ILL2989-A

SEASONAL MAINTENANCE

Seasonal Maintenance services must be performed before, during and after the summer season.

For the CW3 Dual System Rooftop Unit

Pre-Season

1. Ensure the rooftop unit is switched OFF at the MagIQtouch controller.
2. Remove the side panels as shown on the previous page.
3. Remove the filter elements from each side panel. Inspect, and if necessary, replace. If reusing filter elements, ensure they are replaced in the same orientation (dirty face outwards).
4. Replace side panels.
5. Turn on water supply to the rooftop unit (if turned off at end of season).
6. Run the rooftop unit.

WARNING! Ensure the pad frames are fitted when operating the rooftop unit.

During Season

The return air filter must be checked and cleaned by the owner/user at least once every 2 weeks during the heating season. This grille is part of the ductwork, and is usually fitted by the installer to a wall or ceiling inside the house. You can use a vacuum cleaner to clean the return air filter.

If you are unsure how to find, remove, and clean the return air filter, then please contact your local Seeley Dealer or your installer.

Cleaning the return air filter regularly will help to keep the heater running efficiently.

End of Season

1. Isolate power from the rooftop unit. One way of doing this is to disconnect the plug from the power outlet in the ceiling space. Another is to turn the Mains Circuit Breaker (MCB) associated with the rooftop unit OFF.
2. Turn off water supply to the rooftop unit.
3. Remove the side panels as shown on the previous page.
4. Thoroughly clean the tank, pump filter and salinity probe.
5. Reinstall side panels.
6. Reconnect power to the rooftop unit.
7. Trigger a manual drain from the MagIQtouch controller.
8. Clean the return air filter inside the building.

MAINTENANCE SCHEDULE

CW3 DUAL SYSTEM ROOFTOP COOLING UNIT

Service Item	Check/Adjust					Clean					Replace				
	1	2	3	4	5	1	2	3	4	5	1	2	3	4	5
Water Distribution System															
Cooling modules (replace as required)															
Tank/Water Reservoir															
Pump Filter															
Water Probes															
System Washers, Seals and O'Rings (replace as required)															
Drain Valve operation															
Component Function															
Pump operation															
Drain Valve operation															
Motor Operation															
Solenoid operation															
Wall Control operation															
General Operation															
Water Level Set Point															
Water Fill Time															
Water Drain Time															
Airflow through system/Outlets															
General Product condition (includes correct fitting of all components and items - replace as required)															

Service No.	Service Date	Service Technician	Service Company
No.1
No.2
No.3
No.4
No.5

TROUBLESHOOTING

CW3 DUAL SYSTEM ROOFTOP COOLING UNIT

Symptom	Cause	Action
Inadequate cooling	Dry pads	Ensure the water supply is turned on. Then check the water flow to the pads.
	Insufficient exhaust openings for conditioned air	Ensure sufficient exhaust openings.
	Excessive ambient humidity	On days during the summer when the ambient humidity is high, the rooftop cooling unit will not reduce the temperature as much as on drier days.
Cooler turns ON and OFF	Fault in the cooler	Contact your Seeley International authorised dealer or service number.

If your controller prompts you to call a service agent, please contact your local Seeley International authorised dealer or the service number on the back of this manual.

Important! In an emergency we recommend that you immediately cease operating the appliance, and if applicable, have the power and water isolated.

MAINTENANCE SCHEDULE

CW3 DUAL SYSTEM HEATING UNIT

Year	2	4	6	8	10
Name of Technician and company (Print)					
Signature of Technician					
Date of attendance					
Cabinet and components					
Cabinet					
Heat exchanger					
Combustion air inlet louvres					
Condensate drain (If applicable)					
General installation					
Return air grille and filter					
Duct condition					
Flue system, cowl					
Electrical and gas connections					
Electrical					
Electrical wiring					
Room fan motor / impellor					
PCB's					
Pressure switch/s and hoses					
Combustion fan suction pressure					
Gas, burners, ignition					
Burners and injectors					
Ignition electrode					
Flame sense electrode					
Operation					
Start up and run sequence					
Control operation					
Cross-lighting					
Gas inlet pressure	kPa	kPa	kPa	kPa	kPa
Gas test point pressure - High	kPa	kPa	kPa	kPa	kPa
Gas test point pressure - Low	kPa	kPa	kPa	kPa	kPa
Return air temperature					
Outlet air temperature					
Thermistor temperature					
Zone operation (If applicable)					

Action taken key:

✓ = Inspected and working correctly no action required **C** = Cleaning of part
A = Adjustment of part **R** = Replaced part

To owner/user: Please note that as explained in your Product Warranty, installation is not covered by the warranty (for example, ductwork, the return air grille and filter, and electrical and gas connections to the ducted gas heater). However, we still require that you have these things checked, because they can affect the performance (and/or safety) of the heater. This is why we have included them in the Maintenance Schedule.

TROUBLESHOOTING

CW3 DUAL SYSTEM HEATING UNIT

Symptom	Action
House is not heating effectively	<ul style="list-style-type: none"> • Check that the Controller is set to HEAT mode. • Check that Controller is set to required temperature (Set temperature must be above room temperature for heater to start) - increase set temperature if required. • Fan speed may be set too low - try increasing the fan speed. • Check that outlets/zones are open to all areas that require heating. • Check the return air grille is not obstructed. • Check that the return air grille and filter are clean - clean if required. • Check that external doors and windows are closed. • Check the maximum gas rate has not been adjusted down.
Heater operates at wrong times in PROGRAM mode	<ul style="list-style-type: none"> • Check that the time and day displayed are correct. • Check that AM/PM is correct in the program settings. • Check time, temperature, zones and fan speed settings in the program.
Heater does not start - fault code 07 displayed	<ul style="list-style-type: none"> • Check that gas is turned on at gas meter. If the gas is turned off contact your installer or gas supplier.
Set Date and Time screen is displayed	<ul style="list-style-type: none"> • There may have been a power outage. Set Date and Time to resume heater operation.

If your controller prompts you to call a service agent, please contact your local Seeley International authorised dealer or the service number on the back of this manual.

Important! In an emergency we recommend that you immediately cease operating the appliance, and if applicable, have the power and water isolated.

HOW TO REGISTER YOUR PRODUCT WARRANTY (Australia only)

Warranty Information section

HOW TO REGISTER YOUR PRODUCT WARRANTY (Australia only)

Please register your warranty online by visiting [seeleyinternational.com](https://www.seeleyinternational.com) and selecting RESIDENTIAL section on the top right hand side of the screen. Then follow these steps:

Step 1 Select **SUPPORT** then **REGISTER A PRODUCT FOR WARRANTY**

Step 2 Enter your product serial number and "**SUBMIT**"

Step 3 Enter the required information and "**SUBMIT**"

Alternatively, go to <https://www.seeleyinternational.com/residential/support/register-a-product-for-warranty/> which will take you directly to the product warranty registration page.

Important Note: You need to have the following information to complete your registration:

- your unit model and size
- serial number
- date your system was installed
- name of the dealer you purchased it from

Please complete this section. You will also need to retain your purchase receipt, and proof of any warranty period extension.

Brand: _____

Model: _____

Serial No: _____

Customer Name: _____

Installation Address: _____

Installation Type: Residential / Non Residential / Commercial

Date of installation: _____

Installer / Dealer: _____

As with any product that has moving parts or is subject to wear and tear, it is **VERY IMPORTANT** that you maintain your Climate Wizard and have it regularly serviced. It is a condition of warranty cover for your Climate Wizard that you comply with all of the maintenance and service requirements set out in the Owner's Manual. Compliance with these requirements will prolong the life of your Climate Wizard. Further, it is also a condition of warranty cover that each item in the Maintenance Schedule in the Owner's Manual is performed with the frequency indicated, by a qualified, licensed technician, and that the Maintenance Schedule is properly filled out (i.e. names, signature, date, and action taken) when the item is completed.

ANY FAILURE TO CARRY OUT THE REQUIRED MAINTENANCE AND SERVICING REQUIREMENTS, AND ANY FAILURE TO PROPERLY FILL OUT THE MAINTENANCE SCHEDULE, WILL VOID YOUR WARRANTY.

WARRANTY TERMS AND INFORMATION (Australia only)

Warranty Details (Australia only)

In this warranty:

We or **us** means Seeley International Pty Ltd (Seeley) ABN 23 054 687 035, and our contact details are set out at the end of this warranty;

You means you, the original end-user purchaser of the Goods;

Supplier means the authorised distributor or retailer of the Goods that sold you the Goods in Australia;

Goods means the product, unit, appliance or equipment which was accompanied by this warranty and purchased in Australia; and

Relevant Warranty Period means the various warranty periods as described in clause 1 below, as appropriate.

Our Goods come with guarantees that cannot be excluded under the Australian Consumer Law. You are entitled to a replacement or refund for a major failure and for compensation for any other reasonably foreseeable loss or damage. You are also entitled to have the Goods repaired or replaced if the Goods fail to be of acceptable quality and the failure does not amount to a major failure.

In addition to any rights and remedies that You may have under the Australian Consumer Law or any other law, subject to the terms of this warranty, We provide the following warranty:

1. If during the first five (5) years from the date of purchase, the Goods upon examination prove defective by reason of improper workmanship or material, We will repair or replace at our option, the Goods or any part thereof without charge for either parts or labour during normal working hours.
2. The warranty granted under clause 1 applies to all components which form part of the original air cooler, but does not cover:
 - a. fair or normal wear and tear;
 - b. damage, loss or claims caused by, resulting from, or arising out of any utilities that service or are connected to the Goods. This includes but it is not limited to electrical surges, and inadequacies, failure, or other problems in or with any electricity, power, or water supply to the Goods;
 - c. after the first year: the replacement, supply, or servicing of consumable items (including without limitation washers, seals, and drive belts);
 - d. despite clause 2.c. above, the air filters;
 - e. installation (including without limitation ductwork, fittings, and other related installation components) which is excluded and.
 - f. batteries (including damage caused by leaking or faulty batteries), cracking or breaking of display screens in controllers, physical damage caused by the user or third parties, and accidental breakage.
3. During the period to which any expressed warranty applies, all defective part(s) shall be replaced or repaired (at the discretion of Seeley) without charge for either parts or labour, during normal working hours. Should we deem in our absolute discretion to replace the Goods pursuant to clause 1, we may substitute any similar good even if it is not on our current price/equipment list. Further, Goods presented for repair may be replaced by refurbished goods of the same type rather than being repaired. Refurbished parts may be used to repair the Goods.
4. We are under no obligation to repair or replace the Goods or Parts under clause 1 above if (i) the Goods have not been installed and commissioned in accordance with the Installation Instructions (ii) the Goods have not been installed and commissioned properly or competently, (iii) the Goods have not been operated, serviced and maintained in accordance with the instructions provided in the Owner's Manual, or (iv) any such service or maintenance has not been properly or competently performed. The addition of any third party device or the removal or the alteration of any Seeley component or damage due to the misuse of the unit or faulty installation or commissioning will void this warranty. Further, it is a condition of warranty cover that each item in the Maintenance Schedule in the Owner's Manual (if it was published with such a Schedule) is performed with the frequency indicated, by a qualified, licensed technician, and that the Maintenance Schedule is properly filled out (i.e. names, signature, date, and action taken) when the item is completed. Any failure to carry out the required maintenance and servicing requirements, and any failure to properly fill out a Maintenance Schedule in the Owner's Manual, will void your warranty.
5. As far as the law permits, We will not be liable for any consequential loss suffered through, or resulting from, the non-operation, or ineffective operation of the air cooler. The warranties granted under clause 1 do not cover damage to the air cooler or other loss resulting from acts of God.
6. No other person, company or corporation is authorised to offer, or give on our behalf, any other warranty. The benefits conferred are in favour of You and any person deriving title to the air cooler whilst in its original place of installation. Nothing in this warranty shall be construed as affecting any rights You may have under all the relevant laws, or Commonwealth or State Legislation which give You rights which cannot be modified or excluded by agreement.

WARRANTY TERMS AND INFORMATION (Australia only)

7. In order to claim under the warranties granted under clause 1 You must:
- a. either:
 - contact us within the Relevant Warranty Period on: 1300 650 644; or
 - log a warranty claim on our website (website address below) within the Relevant Warranty Period; and
 - b. make available for inspection by the service agent who will come to the location of the Goods or send to us at the address below within the Relevant Warranty Period: (i) the legible and unmodified original proof of purchase, which clearly indicates the name and address of the original retailer, the date and place of purchase, the product name or other product serial number, (ii) all of your records of all service and maintenance carried out to the Goods, plus the Maintenance Schedule in the Owner's Manual (if it was published with such a Schedule) (iii) a copy of the completed Warranty Information page in this warranty, and (iv) if an extended warranty period was provided by us for the Goods, then the relevant document provided by us confirming that extended warranty period. If you choose to send the documents described in (i) to (iv) to us, then they must be accompanied by a covering letter which states your name and address and daytime telephone number, the address at which the Goods are installed, and the model and serial number of the Goods.
8. The warranty granted in clause 1 covers the costs of parts and labour but you will be responsible for:
- a. the cost of travel incurred for a Seeley International service agent to get to and from the location of the Goods if the location of the Goods is either: (i) outside the metropolitan areas of the capital cities; or (ii) more than 35 kilometres from an authorised Seeley International branch or service representative; and
 - b. any costs for additional labour or equipment associated with gaining acceptable and safe service access to the Goods installed in restricted, high or unsafe locations, and or the removal and replacement of any barrier, walls, roofs, floors, fences etc.; and
 - c. any costs incurred by the Seeley International service agent in gaining access to the Goods which is necessary to comply with any safety or workplace safety requirements and/or any other relevant regulations. For the avoidance of doubt, the reference to any costs incurred also includes the cost of any necessary site inductions.
9. We are not responsible in any way for any failure and/or inadequate performance of the Goods which arises from or is connected to the use in the Goods of non-genuine spare parts. We strongly recommend that only spare parts supplied or approved by us are used in the Goods.
10. We are not responsible for the installation of the Goods and expressly disclaim all liability resulting from incorrect installations or installations that do not conform to local electrical codes, local plumbing codes, Occupational Health and Safety requirements, and by laws which are legislated or in effect at the time of installation.
11. This warranty is only valid and enforceable in Australia.

Note: We and our service agents reserve the right to refuse service unless safety and accessibility to the unit can be guaranteed.

If a service call reveals no warranty fault found with the Goods, a charge will be made for the call.

Our liability under this warranty is limited to the extent permitted by law. That is, to the extent that it is fair and reasonable, if the Goods are not of a kind ordinarily acquired for personal, domestic or household use or consumption, your remedies associated with any failure or defect of the Product will be limited to:

- a. the replacement of the Goods or the supply of equivalent goods;
- b. the repair of the Goods;
- c. the payment of the cost of replacing the Goods or of acquiring equivalent goods;
- d. the payment of the cost of having the Goods repaired

and subject to the terms and conditions included in this warranty.

WARRANTY TERMS AND INFORMATION (Australia only)

SERVICE DEPARTMENT

Seeley International Pty Ltd

112 O'Sullivan Beach Road

Lonsdale, South Australia 5160

Customer service centre 1300 650 644

Website: www.seeleyinternational.com

FOR SERVICE

Service call Booking

To book a Service on your Seeley International product Online visit www.seeleyinternational.com and selecting COMMERCIAL section on the top right hand side of the screen. Then follow these steps:

FOR SERVICE

Service call Booking

To book a Service on your Seeley International product Online visit www.seeleyinternational.com

Step 1 Select **"SUPPORT"** and **"BOOK A SERVICE"**.

Step 2 On the **"FIND A SERVICE AGENT"** page, enter your **POSTCODE** and select a category (for example **"CW3 DUAL SYSTEM"**), select the **"SEARCH"** button.

Step 3 On the **"RESULTS"** page, select the **"BRAND"** of your cooler.

Step 4 Choose **"SELECT"** for your preferred agent from the list provided.

Step 5 Select **"BOOK A SERVICE"**.

or Phone 1300 650 644 to be directed to your closest authorised Service Agent.

PRIVACY NOTICE

Seeley International Pty Ltd ABN 23 054 687 035 will use the personal information you provide us with to provide warranty support for the product you have purchased and to inform you about other products and services. If you choose not to supply us with the information requested, we may be unable to provide you with warranty support. We may also disclose your information to third parties, such as related entities; retailers, distributors, service agents and contractors who are affiliated with us; or marketing or market research companies. If you would prefer not to receive direct marketing communications from us, please follow the instructions to "unsubscribe" which will be included in the direct marketing communications we send you, or contact our Privacy Officer using the details set out below. While we do not currently transfer personal information to overseas recipients or store personal information overseas, if we transfer your information to third parties who do so, we will take reasonable steps to ensure that the overseas recipients do not breach the *Australian Privacy Principles*. By registering your warranty, you consent to having your personal information used in this way. Please read our Privacy Policy on our website www.seeleyinternational.com for further explanation of how we collect, use, hold and disclose personal information, and how you may access and seek correction of your information. It also sets out how you may complain about a breach of the Australian Privacy Principles, and how we will deal with your complaint. You may contact us at: Privacy Officer, Seeley International Pty Ltd, 112 O'Sullivan Beach Road, Lonsdale, South Australia 5160.

When your product requires servicing, please
quote the cooler serial and model number

Affix serial & model
number sticker here

Warranty (Australia only)

To register your warranty, go to
www.seeleyinternational.com/register-warranty



Service

For Australia contact 1-300-650-644
For outside Australia contact your local dealer

seeleyinternational.com

MANUFACTURED BY: SEELEY INTERNATIONAL PTY LTD
112 O'SULLIVAN BEACH RD, LONSDALE SA, 5160. AUSTRALIA

IMPORTED BY: SEELEY INTERNATIONAL (EUROPE) LTD
UNIT 11 BYRON BUSINESS CENTRE DUKE STREET,
HUCKNALL NOTTINGHAM, NG15 7HP UNITED KINGDOM

SEELEY INTERNATIONAL (AMERICAS) LTD
1002 S 56TH AVENUE, SUITE # 101
PHOENIX, ARIZONA 85043, USA

SEELEY INTERNATIONAL (AFRICA) PTY LTD
6 WITTON ROAD, FOUNDERSVIEW SOUTH,
MODDERFONTEIN 1609, GAUTENG, SOUTH AFRICA

It is the policy of Seeley International to introduce continual product improvement.

Accordingly, specifications are subject to change without notice.

Please consult with your dealer to confirm the specifications of the model selected.

