



**The world's leading
hyper-efficient air conditioner
with an exceptional compact footprint**



Advanced HVAC Technology



World leading climate control solutions

Seeley International is Australia's largest air conditioning manufacturer and a global leader in developing ingenious, energy-efficient cooling and heating products.

Award Winning Company

Seeley International consistently wins awards each year for new product design, innovation and environmental friendliness.

Recent awards include:



The world's coolest, quietest and most energy efficient evaporative air conditioners*



High performance evaporative air conditioning. Unbelievable value.



Hyper-efficient indirect evaporative air conditioners



Compact, modular indirect evaporative air conditioners



About Climate Wizard

Climate Wizard's unique indirect evaporative heat exchange core provides hyper-efficient cooling of outside air. Generate **100% fresh, cool, outside air**, at temperatures that rival refrigerated systems, with up to **80% lower energy costs.**¹



Reduces the energy use and improves the cooling performance of existing refrigerated systems
 No high electrical demand charges even in hot weather
 Savings on the installation costs



Improved IAQ (indoor air quality) with 100% outside air
 Total cooling performance increases when air temperature rises



Covers an exceptionally large range of flexible configurations in a wide range of industries
 Supported by a team of experienced design consultants and engineers



Wiser use of water (R-718)
 No synthetic refrigerants or chemicals to harm the environment



Simple, reliable solution to improve COP / EER (coefficient of performance / energy efficiency ratio)
 Tested in NATA (National Association of Testing Authorities) accredited laboratory



Australian designed, made and owned!
 Designed for easy maintenance
 International sales and technical support

The future of cooling. Climate Wizard CW3.

Micro-Core® technology - The secret to hyper-efficient cooling.

Climate Wizard CW3 uses Seeley International's latest innovation, a new Micro-Core® technology for smaller or uniquely challenging applications. The concept of how it works remains unchanged, combined with equally effective cooling performance found in Climate Wizard's other commercial models; such as the CW-P15, CW-H15 and CW-80.



Outstanding cooling performance.

CW3 provides hyper-efficient cooling of outside air and up to **80% lower cooling energy costs**¹, compared to equivalent reverse cycle systems, with the added benefit of supplying 100% fresh, cool air into the building, increasing Indoor Air Quality (IAQ).

CW3 delivers incredible part load performance due to its inverter technology fans. During conditions where the full cooling requirement is not needed, the CW3 is able to provide a part load COP up to 20 and an input power of only 300W at low speed. The CW3 contains an on-board sophisticated control system that ensures peak efficiency during all operating conditions.

New Micro-Core® counter-flow heat exchanger.

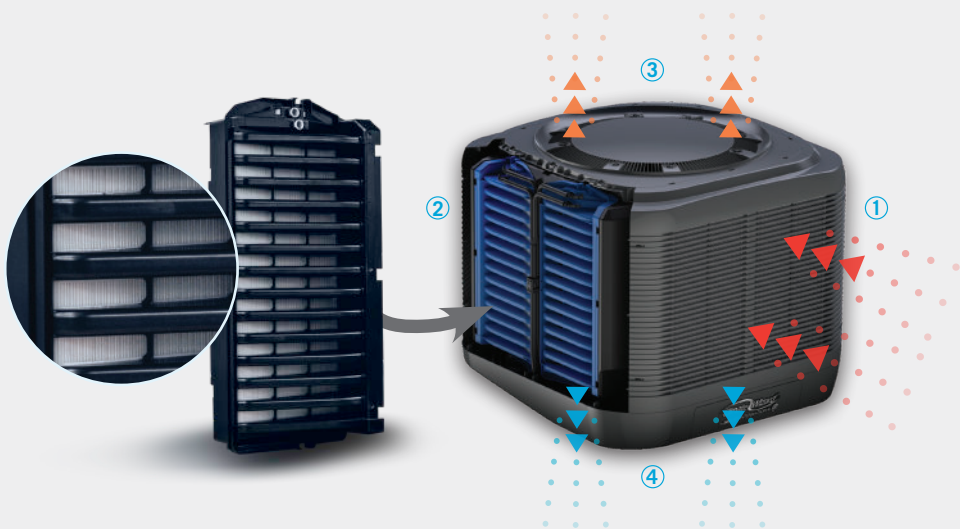

How it works.

- ① Hot air enters the cooler
- ② Hot air passes through the Micro-Core®
- ③ Warm, moist air exhausted outside
- ④ Fresh, cool outside air passes into the building

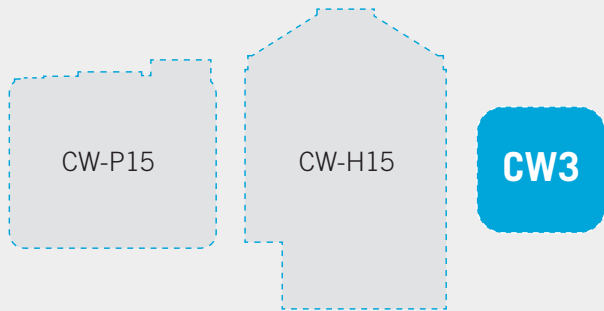

CW3 provides an energy-efficient cooling alternative into buildings where reverse cycle was previously the only option. Its ingenious design has enabled an extremely compact footprint.

Our other Climate Wizard offerings suit an extensive range of installation types and now the CW3 provides a more compact option, opening up new installation opportunities where plant room or roof space is restricted.

A wide range of applications.

Designed to meet the cooling and fresh air requirements of buildings across many sectors, particularly where there is constant access by customers or occupants, spaces constantly open to outdoors or where doors are frequently opening and closing.



Business owners can cut up to 80% of their cooling energy costs which is critical to their bottom line.¹

CW3 also delivers optimal cooling performance in specialised applications including:

- Exhaust / make-up air applications such as commercial kitchens / food preparation and laundries
- Spot cooling above work stations to cool equipment or workers in processing, manufacturing or warehouse environments boosting staff productivity and well-being as well as customer comfort.

Advanced next generation smart controllers.

Optional with CW3

MagIQtouch® controller.



Optional with CW3

MagIQtouch® BMS industrial controller MS1.



Supply air temperature

Location	Design condition	CW3 Leaving Air Temp (°C)	Stand Alone Cooling Capacity (kW)	COP
Arid	42°C DB / 21°C WB	19.5	10	6.8
Temperate	37°C DB / 19°C WB	17.8	14	8.4
Continental	31°C DB / 20°C WB	19.7	12	7.2
Sub-Tropical	31°C DB / 23°C WB	23.0	7	4.3



¹Compared to standard efficiency systems performing the same duty. Dependent on final system design for individual applications. We recommend consultation with a Seeley International Sales Engineer to establish the most appropriate product selection.



Performance comparison

Climate Wizard vs refrigerated cooling as temperature rises

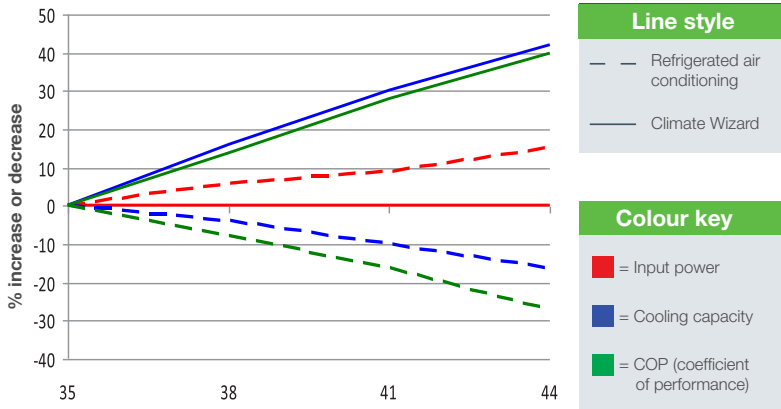

Outdoor Temperature (Degrees Celsius DB)
Source: Uni SA Roxby Downs Report June 2009

Climate Wizard's cooling performance can rival that of refrigerated systems, using up to 80% less energy.¹

That's not only great for reducing power bills; it's also great for the environment. And, no matter how hot it gets outside, Climate Wizard uses the same amount of power and still delivers 100% fresh, cool air inside.

This is in direct contrast to refrigerated systems, which require increasing amounts of power as outside temperatures rise. Climate Wizard's cost-saving capabilities actually increase, when the heat is at its highest.

At the same time, Climate Wizard's performance also increases as temperatures rise – again, in complete contrast to refrigerated systems.

Psychrometric chart

Barometric pressure 101.3kPa

The coloured lines on the psychrometric chart compare Climate Wizard's performance to that of a direct evaporative cooler on a hot day.

- Direct evaporative cooling
- Climate Wizard CW3 indirect-direct evaporative air conditioning

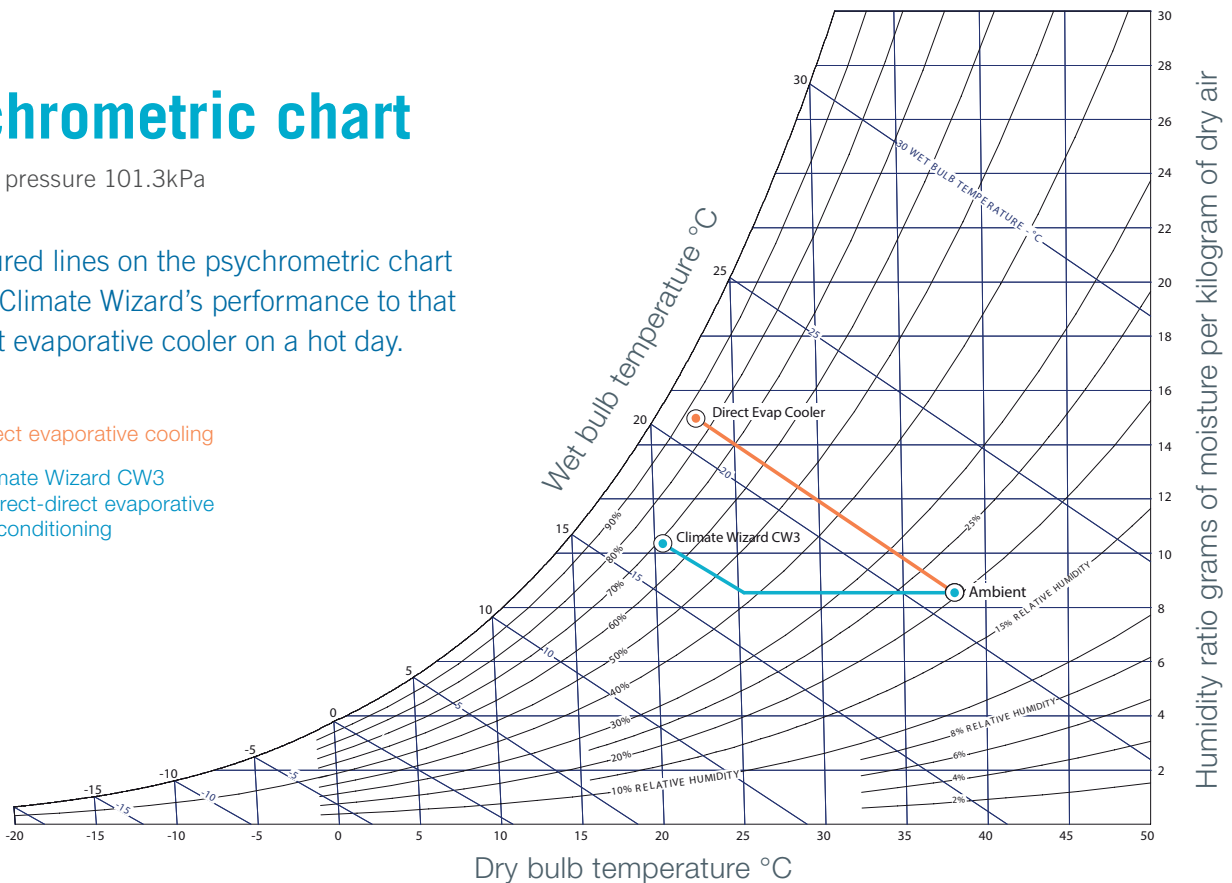

Technical Specifications

CW3		
Operation	Voltage/Phases/Hz	220-240 V / 1 / 50-60 Hz
	Power	1,750W
	Current Draw Rated	7.0A
	Stand alone Cooling Capacity ¹	12.0 kW
	Airflow @ 50Pa	1,490 L/s 5,360 m ³ /hr
Fans	Fan Type	Supply: Axial Exhaust: Centrifugal-Backward Curved
	Motor Type	Inverter driven variable speed
	Motor Output	Supply: 750W Exhaust: 950W
	Motor Overload Protection	'One-Shot' fuse
Pumps	Type	Centrifugal (Vertical)
	Motor	2 Pole Synchronous
	Power – rated	30W
	Flow Rate	13LPM @ 1.5 Head
	Voltage / Phases / Hz	220-240 V / 1 / 50-60 Hz
	Overload	'One-Shot'
Heat Exchanger Cores	Climate Wizard Patented 2-Stage Heat Exchanger Cores	Indirect: x8 Direct: x8
Water	Water Supply	Min.100kPa & 10L/min Max.800kPa & 20L/min Connection ½" BSP
	Water Drain	Water Drain Connection 1½" BSP
	Tank Capacity	30L
Filtration	Air Filters	8x Type G4 Standard Cartridge Aluminium Washable 635mm x 356mm x 25mm
Shipping	Dimensions	1175mm (L) x 1175mm (W) x 1045mm (H)
	Weight	210kg
Installation	Connected Duct	530 x 530mm
	Operating Weight	240kg

Note: specifications subject to change. ¹Max Cooling Capacity tested in accordance with ASHRAE 143 conditions of 38.0 °C db / 21.0 °C wb in accordance with Australian Standard AS2913.

Cabinet details

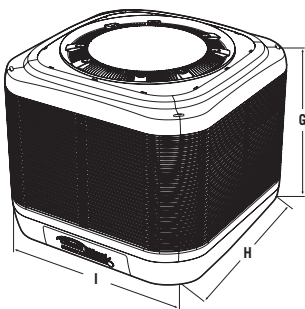

Side View

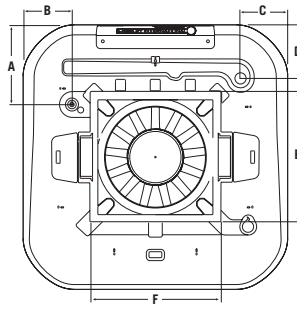

Service View

Model	A	B	C	D	E	F	G	H	I
CW3 (mm)	346 Inlet	212 Inlet	204 Drain	230 Drain	570*	565*	1018	1157	1157

*Suits 530mm dropper

Fan curve

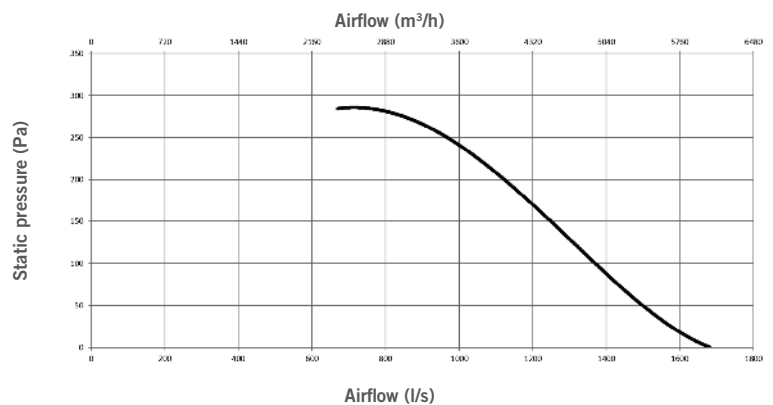

²Note: specifications subject to change. ³Max Cooling Capacity tested in accordance with ASHRAE 143 conditions of 38.0 °C db / 21.0 °C wb in accordance with Australian Standard AS2913.



BREEZAIR

Direct Evaporative Air Conditioning

CLIMATE WIZARD

Indirect Evaporative Air Conditioning

COOLAIR

Direct Evaporative Air Conditioning

COOLERADO

Indirect Evaporative Air Conditioning

seeleyinternational.com
eurosales@seeleyinternational.com
uksales@seeleyinternational.com

Seeley International Europe (Italy) s.r.l.
Policiano 72M
52100 Arezzo Italy
Phone: +39 (0)575 97189
Fax: +39 (0)575 1949971
eurosales@seeleyinternational.com
seeleyinternational.com

Seeley International France
320 Avenue Berthelot
69371 Lyon cedex 08 France
Phone: +33 (0)472 7847 80
Fax: +33 (0)472 8476 71
eurosales@seeleyinternational.com
seeleyinternational.com

Seeley International (UK) Pty Ltd
Unit 11 Byron Business Centre
Duke Street, Hucknall Nottingham
NG15 7HP United Kingdom
Phone: +44 (0)115 9635630
Fax: +44 (0)115 9635630
uksales@seeleyinternational.com
seeleyinternational.com



Information in this brochure was correct at the time of preparation. E & OE